



PROGRAMMÜBERSICHT
PROGRAMM OVERVIEW



DUSCHSYSTEME | SHOWER SYSTEMS



Duschsysteme/-beschläge	Shower systems/-fittings	4
Duschsysteme/-beschläge für Sonderlösungen	Shower systems/-fittings special solutions	26
Profile & Zubehör	Profiles & Accessories	30
Produktzertifizierung & Ausstellungsmodule	Product certification & Demonstration modules	31
Funktionsübersicht	Overview of functions	34
Anwendungstypen	Application types	36

ERLEBEN SIE GRAL DUSCHSYSTEME EXPERIENCE GRAL SHOWER SYSTEMS

Besuchen Sie unseren Showroom in Rietberg

gral Duschsysteme können Sie in unserer großen Ausstellung im ostwestfälischen Rietberg live erleben – in verschiedenen Ambientes, in vielfältigen Einbausituationen und in der Kombination mit diversen Glasdesigns.

Lassen Sie sich inspirieren – vereinbaren Sie bitte einen Besuchstermin unter Telefon +49 (0) 5244 90 76-0.

Come and visit our showroom in Rietberg, Germany

gral shower systems can be seen at first hand in our showroom in Rietberg in the north-west of Germany. They are displayed in various environments and installation situations, as well as in combination with a wide range of glass designs.

Discover inspiration. Simply phone us to arrange a time to visit: +49 (0) 5244 90 76-0.

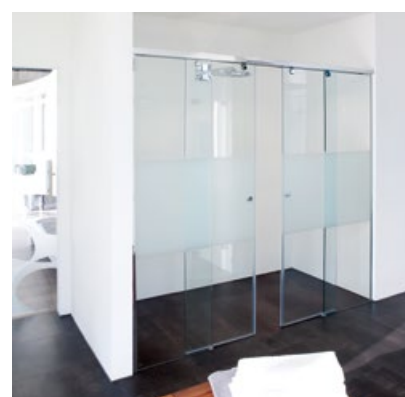



Keine Dusche ist wie die andere

Die individuellen Wünsche an die richtige Dusche sind so vielfältig wie die baulichen Voraussetzungen im Bad. Mit der großen Auswahl an Funktionsbeschlägen von gral lässt sich praktisch jede persönliche Traumduche verwirklichen – ob mit Hebe-/Senk- oder Pendelmechanik, als Schiebetür, Drehtür, Falt- oder Walk-In Lösung, punktgehalten oder geklemmt.

Every shower is different

Individual requirements for the ideal shower are as diverse as the layouts of bathrooms themselves. With the wide range of gral functional fittings, almost any dream shower can be realized – whether with a rising or double-action mechanism, sliding or swing door, single-point fixing or clamp fittings, or as a folding-door or walk-in solution.



Glasstärke
Glass thickness



max. Tragfähigkeit (2 Beschläge)
max. loading capacity (2 fittings)



Glasbefestigung mit Gegenplatte
Glass fixing with counterplate



Glasbefestigung flächenbündig
Countersunk glass fixing



Soft Closing
Soft Closing



einstellbare Nullstellung
adjustable zero positioning



ANSCHLAGTÜRSYSTEME
SINGLE-ACTION DOOR SYSTEMS

8



BO 410 BO 415 BO 460



SYSTEME MIT HEBE-SENK-FUNKTION
SYSTEMS WITH LIFT-LOWER-FUNKTION

10

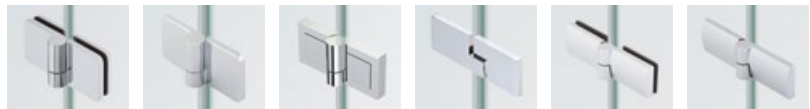

BH 200 BH 205 BH 210 BH 2401 BH 410 BH 415



PENDELTÜRSYSTEME
DOUBLE-ACTION DOOR SYSTEMS

14



BF 111 BF 112 BF 112 XL BF 134 BO 381 BH 2401



FALTTÜRSYSTEME
FOLDING DOOR SYSTEMS

18



BF 134 BO 305



SCHIEBETÜRSYSTEME
SLIDING DOOR SYSTEMS

20



SO 720 SO 730/3 SO 750 SF 740



WALK-IN SYSTEME
WALK-IN SYSTEMS

24



QUADRAT PO 570 TYP(E) 530W TYP(E) 530P

Was der Tag auch mit uns vor hat – mit gral fängt er schon mal gut an.

Wenn wir am Morgen eine frische Dusche in einem schönen Ambiente genießen, wird der Tag schnell unser Freund. Die innovativen gral Duschbeschläge und Duschesysteme, einige davon mit Designpreisen ausgezeichnet, ermöglichen eine helle, transparente Badgestaltung mit Glas.

gral steht für qualitativ hochwertige Duschbeschläge für den öffentlichen und privaten Bereich. Die Duschelemente werden montagefertig für den Einsatz mit ESG nach individuellem Aufmaß geliefert. Mit höchsten Installationskomfort, und mit dem Zubehör im passenden Design: Technik und Design aus einem Guss.

Whatever the day has in store – with gral you're guaranteed a great start.

A refreshing shower in a relaxed atmosphere first thing in the morning is the perfect start to the day. Award-winning, innovative gral shower fittings and shower systems enable a light, transparent bathroom design based on glass.

gral offers high-quality shower fittings for public and private spaces. The made-to-measure shower elements are supplied ready for fitting with toughened safety glass in accordance with your individual spatial requirements. Maximum ease of installation and accessories in matching designs ensure a perfect package of technology and style.

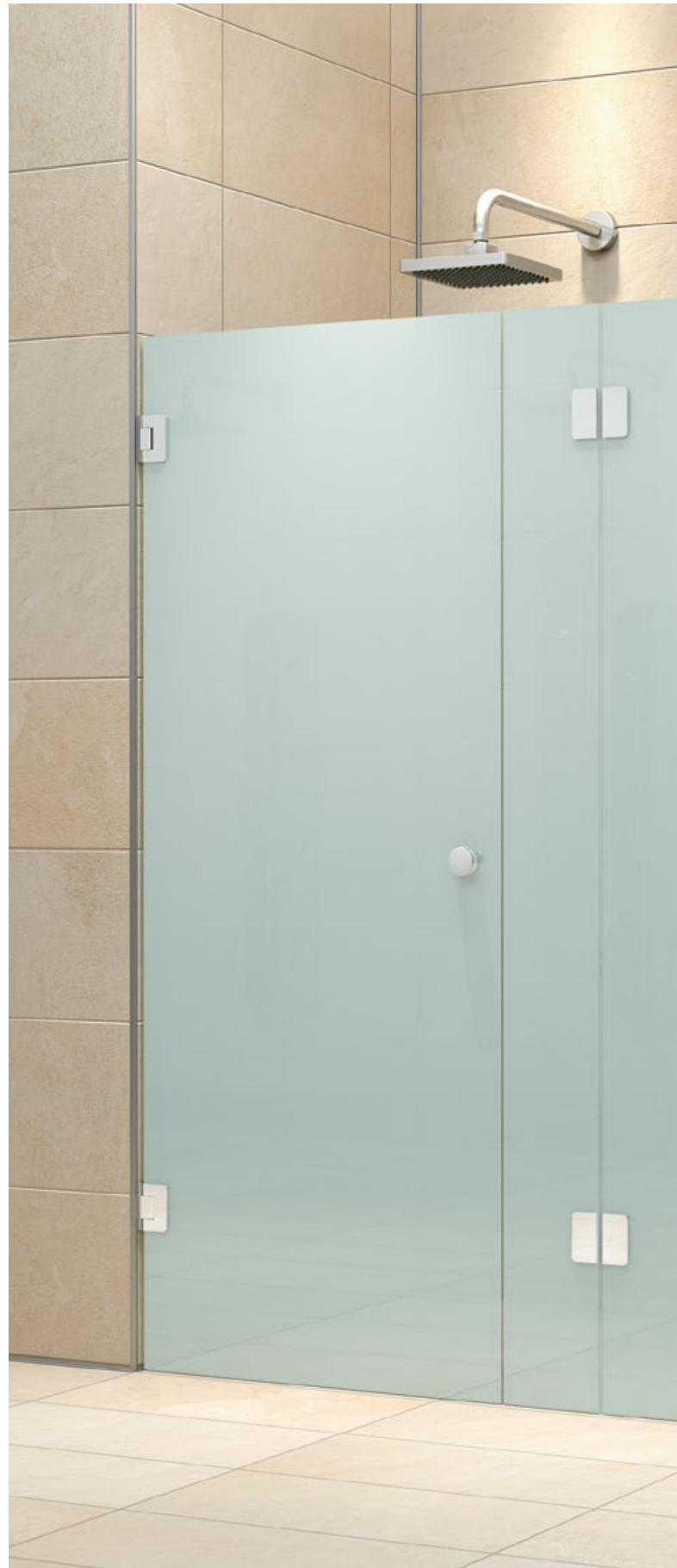



Unser Anspruch – und was Sie davon haben

Die hohen Erwartungen unserer Kunden an die Marke gral sind identisch mit unseren eigenen Ansprüchen an die Produkt- und Servicequalität. Wir sind erst zufrieden, wenn die Funktionalität unserer Duschsysteme perfekt mit dem Design zusammenspielt.

Our quality standards – and what they mean for you

The high expectations our customers have for the gral brand correspond completely with our own standards of product and service quality. Like us, you are only satisfied when the functionality of the shower system fully matches its design excellence.

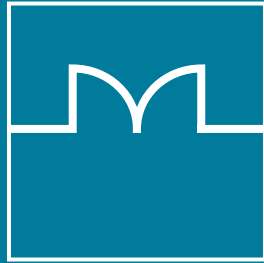

ANSCHLAGTÜRSYSTEME SINGLE-ACTION DOOR SYSTEMS

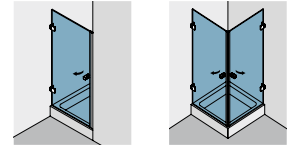

100

120

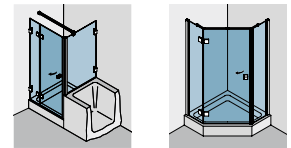

231W/P

255W/P

Hier sehen Sie nur eine kleine Auswahl möglicher Einbauvarianten. Alle mit dem System realisierbaren Anwendungstypen finden Sie ab Seite 36.

Here are a few installation examples. All realizable system application types see from page 36.

BO 410

Anschlagtürsystem

- nach außen öffnend
- Glasbefestigung mit Gegenplatte
- durchgehende Dichtungen an allen Glaskanten
- vielfältige Beschlagsvarianten

Single-action door system

- Outward opening
- Glass fixing with counter plate
- Continuous seals along all glass edges
- Wide range of fittings



- 1 Band Glas/Wand
Hinge glass/wall
- 2 Band Glas/Glas 180° (außen)
Hinge glass/glass 180° (outside)
- 3 Band Glas/Glas 180° (innen)
Hinge glass/glass 180° (inside)

BO 415

Anschlagtürsystem

- nach außen öffnend
- Glasbefestigung flächenbündig
- durchgehende Dichtungen an allen Glaskanten
- vielfältige Beschlagsvarianten

Single-action door system

- Outward opening
- Countersunk glass fixing
- Continuous seals along all glass edges
- Wide range of fittings



- 1 Band Glas/Wand
Hinge glass/wall
- 2 Band Glas/Glas 180° (außen)
Hinge glass/glass 180° (outside)
- 3 Flächenbündige Glasbefestigung
Countersunk glass fixing

BO 460

Anschlagtürsystem

- nach außen öffnend
- Glasbefestigung flächenbündig
- durchgehende Dichtungen an allen Glaskanten
- quadratisches Design

Single-action door system

- Outward opening
- Countersunk glass fixing
- Continuous seals along all glass edges
- Square design



- 1 Band Glas/Wand
Hinge glass/wall
- 2 Band Glas/Glas 180° (außen)
Hinge glass/glass 180° (outside)
- 3 Flächenbündige Glasbefestigung
Countersunk glass fixing

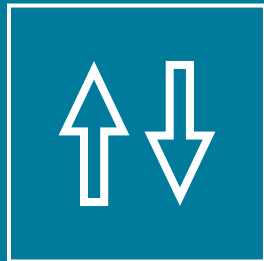

SYSTEME MIT HEBE-SENK-FUNKTION SYSTEMS WITH LIFT-LOWER-FUNKTION

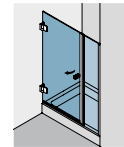

110W/P

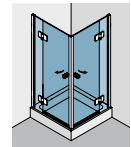

220W/P

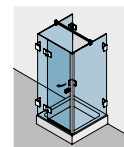

233W/P

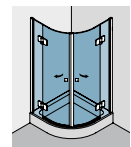

260W/P

Hier sehen Sie nur eine kleine Auswahl möglicher Einbauvarianten. Alle mit dem System realisierbaren Anwendungstypen finden Sie ab Seite 36.

Here are a few installation examples. All realizable system application types see from page 36.

BH 200

Anschlagtürsystem

- nach außen öffnend
- Hebe-/Senkfunktion (+/-5 mm)
- selbstschließend ab 90°
- durchgehende Dichtungen an allen Glaskanten

Single-action door system

- Outward opening
- Lift-/lower function (+/-5 mm)
- Self-closing from 90°
- Continuous seals along all glass edges



- 1 Band Glas/Wand
Hinge glass/wall
- 2 Band Glas/Glas 180° (außen)
Hinge glass/glass 180° (outside)
- 3 Band Glas/Glas 180° (innen)
Hinge glass/glass 180° (inside)

BH 205

Anschlagtürsystem

- nach außen öffnend
- Hebe-/Senkfunktion (+/-5 mm)
- selbstschließend ab 90°
- durchgehende Dichtungen an allen Glaskanten

Single-action door system

- Outward opening
- Lift-/lower function (+/-5 mm)
- Self-closing from 90°
- Continous seals along all glass edges



1



2



3

1 Band Glas/Wand
Hinge glass/wall

2 Band Glas/Glas 180° (außen)
Hinge glass/glass 180° (outside)

3 Flächenbündige Glasbefestigung
Countersunk glass fixing

BH 210

Anschlagtürsystem

- nach außen öffnend
- Glasbefestigung verschweißt statt verschraubt – ohne Glasbearbeitung
- Hebe-/Senkfunktion (+/-5 mm)
- selbstschließend ab 30°

Single-action door system

- Outward opening
- Countersunk glass fixing, strenght welded instead of screwed – non glass prepa.
- Lift-/lower function (+/-5 mm)
- Self-closing from 30°



1



2



3

1 Band Glas/Wand
Hinge glass/wall

2 Band Glas/Glas 180° (außen)
Hinge glass/glass 180° (outside)

3 Flächenbündige Glasbefestigung
Countersunk glass fixing



BH 2401

Pendeltürsystem

- nach innen/außen öffnend
- Hebe-/Senkfunktion (+/-5 mm)
- selbstschließend ab 90°
- mit versetzten Glaskanten
- Design eckig oder rund

Double-action door system

- Inward/outward opening
- Lift-/lower function (+/-5 mm)
- Self-closing from 90°
- Offset glass edges
- Design square or round



1 Band Glas/Glas 180° (eckig)
Hinge glass/glass 180° (square)

2 Flächenbündige Glasbefestigung
Countersunk glass fixing

3 Winkel Glas/Wand 90° (eckig)
Bracket glass/wall 90° (square)

BH 2401

Pendeltürsystem

- nach innen/außen öffnend
- Hebe-/Senkfunktion (+/-5 mm)
- selbstschließend ab 90°
- mit versetzten Glaskanten
- Design eckig oder rund

Double-action door system

- Inward/outward opening
- Lift-/lower function (+/-5 mm)
- Self-closing from 90°
- Offset glass edges
- Design square or round



1 Beschlagseinheit Glas/Wand (rund)
Hinge unit glass/wall (round)

2 Band Glas/Glas 180° (rund)
Hinge glass/glass 180° (round)

3 Flächenbündige Glasbefestigung
Countersunk glass fixing

BH 410

Anschlagtürsystem

- nach außen öffnend
- Hebe-/Senkfunktion (+/-5 mm)
- selbstschließend ab 90°
- durchgehende Dichtungen an allen Glaskanten

Single-action door system

- Outward opening
- Lift-/lower function (+/-5 mm)
- Self-closing from 90°
- Continuous seals along all glass edges



1



2



3

- 1 Band Glas/Wand
Hinge glass/wall
- 2 Band Glas/Glas 180° (außen)
Hinge glass/glass 180° (outside)
- 3 Band Glas/Glas 180° (innen)
Hinge glass/glass 180° (inside)

BH 415

Anschlagtürsystem

- nach außen öffnend
- Hebe-/Senkfunktion (+/-5 mm)
- selbstschließend ab 90°
- durchgehende Dichtungen an allen Glaskanten

Single-action door system

- Outward opening
- Lift-/lower function (+/-5 mm)
- Self-closing from 90°
- Continuous seals along all glass edges



1



2



3

- 1 Band Glas/Wand
Hinge glass/wall
- 2 Band Glas/Glas 180°
Hinge glass/glass 180°
- 3 Flächenbündige Glasbefestigung
Countersunk glass fixing



PENDELTÜRSYSTEME DOUBLE-ACTION DOOR SYSTEMS

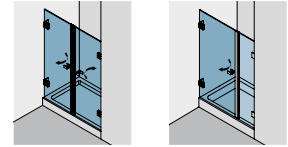

105

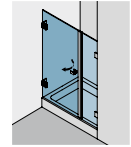

110W/P



200W/P

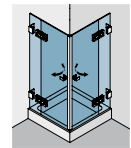

220W/P

Hier sehen Sie nur eine kleine Auswahl möglicher Einbauvarianten. Alle mit dem System realisierbaren Anwendungstypen finden Sie ab Seite 36.

Here are a few installation examples. All realizable system application types see from page 36.

BF 111

Pendeltürsystem

- nach innen/außen öffnend
- Türbeschläge mit Federmechanismus
- selbstschließend ab 20°
- einstellbare Nullstellung

Double-action door system

- Inward/outward opening
- Door fittings with spring mechanism
- Self-closing from 20°
- Adjustable zero positioning



1 Band Glas/Wand
Hinge glass/wall

2 Band Glas/Glas 180°
Hinge glass/glass 180°

3 Band Glas/Glas 90°
Hinge glass/glass 90°

BF 112

Pendeltürsystem

- nach innen/außen öffnend
- Türbeschläge mit Federmechanismus
- selbstschließend ab 20°
- einstellbare Nullstellung

Double-action door system

- Inward/outward opening
- Door fittings with spring mechanism
- Self-closing from 20°
- Adjustable zero positioning



reddot award 2014
winner



1



2



3

1 Band Glas/Wand
Hinge glass/wall

2 Band Glas/Glas 180°
Hinge glass/glass 180°

3 Band Glas/Glas 90°
Hinge glass/glass 90°

BF 112 XL

Pendeltürsystem

- nach innen/außen öffnend
- Türbeschläge mit Federmechanismus
- für Glasduschen mit XL-Abmessungen
- einstellbare Nullstellung
- selbstschließend ab 20°

Double-action door system

- Inward/outward opening
- Door fittings with spring mechanism
- For glass showers with XL-dimensions
- Adjustable zero positioning
- Self-closing from 20°



1



2



3

1 Band Glas/Wand XL
Hinge glass/wall XL

2 Band Glas/Glas 180° XL
Hinge glass/glass 180° XL

3 Band Glas/Glas 90° XL
Hinge glass/glass 90° XL



BF 134

Pendeltürsystem

- nach innen/außen öffnend
- selbstschließend ab 20°
- Türbeschläge mit Federmechanismus
- vielfältige Beschlagsvarianten

Double-action door system

- Inward/outward opening
- Self-closing from 20°
- Door fittings with spring mechanism
- Wide range of fittings



1 Band Glas/Wand
Hinge glass/wall

2 Band Glas/Glas 180°
Hinge glass/glass 180°

3 Band Glas/Glas 90°
Hinge glass/glass 90°

BO 381

Pendeltürsystem

- nach innen/außen öffnend
- inkl. Anschlagsschutz
- durchgehende Dichtungen an allen Glaskanten
- quadratisches Design

Double-action door system

- Inward/outward opening
- Integrated impact protector
- Continuous seals along all glass edges
- Square design



1 Band Glas/Wand
Hinge glass/wall

2 Band Glas/Glas 180° (außen)
Hinge glass/glass 180° (outside)

3 Flächenbündige Glasbefestigung
Countersunk glass fixing

BH 2401

Pendeltürsystem

- nach innen/außen öffnend
- Hebe-/Senkfunktion (+/-5 mm)
- selbstschließend ab 90°
- mit versetzten Glaskanten
- Design eckig oder rund

Double-action door system

- Inward/outward opening
- Lift-/lower function (+/-5 mm)
- Self-closing from 90°
- Offset glass edges
- Design square or round



Design eckig s. S. 12 | Design square see page 12



1



2



3

- 1 Band Glas/Glas 180° (rund)
Hinge glass/glass 180° (round)
- 2 Flächenbündige Glasbefestigung
Countersunk glass fixing
- 3 Winkel Glas/Wand 90° (rund)
Bracket glass/wall 90° (round)

BH 2401

Pendeltürsystem

- nach innen/außen öffnend
- Hebe-/Senkfunktion (+/-5 mm)
- selbstschließend ab 90°
- mit versetzten Glaskanten
- Design eckig oder rund

Double-action door system

- Inward/outward opening
- Lift-/lower function (+/-5 mm)
- Self-closing from 90°
- Offset glass edges
- Design square or round



Design rund s. S. 12 | Design round see page 12



1



2



3

- 1 Beschlagseinheit Glas/Wand (eckig)
Hinge unit glass/wall (square)
- 2 Band Glas/Glas 180° (eckig)
Hinge glass/glass 180° (square)
- 3 Flächenbündige Glasbefestigung
Countersunk glass fixing



FALTTÜRSYSTEME FOLDING DOOR SYSTEMS

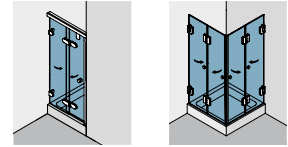

400(ü)

420

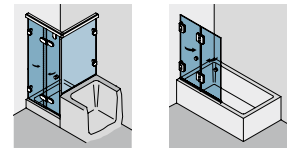

431W(ü)

470

Hier sehen Sie nur eine kleine Auswahl möglicher Einbauvarianten. Alle mit dem System realisierbaren Anwendungstypen finden Sie ab Seite 36.

Here are a few installation examples. All realizable system application types see from page 36.

BF 134

Falt-/Pendeltürsystem

- raumsparend
- Badewannenaufsatz
- Band Glas/Glas ohne Federmechanismus
- rahmenlos

Folding-/Double-action door system

- Space saving
- Bathtub application
- Hinge glass/glass without spring mechanism
- Frameless

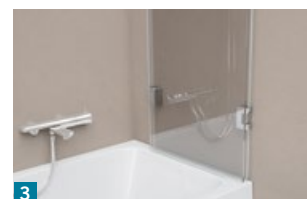

1 Band Glas/Glas 180° (außen)
Hinge glass/glass 180° (outside)

2 Band Glas/Glas 180° (innen)
Hinge glass/glass 180° (inside)

3 Typ 470 geöffnet
Type 470 open

BF 134

Falt-/Pendeltürsystem

- raumsparend
- Band Glas/Glas ohne Federmechanismus
- großzügiger Duscheinstieg
- barrierefrei
- rahmenlos

Folding-/Double-action door system

- Space saving
- Hinge glass/glass without spring mechanism
- Spacious shower entry
- Barrier-free compatible
- Frameless



1



2



3

1 Band Glas/Glas 180° (außen)
Hinge glass/glass 180° (outside)

2 Band Glas/Glas 180° (innen)
Hinge glass/glass 180° (inside)

3 Typ 420 geöffnet
Type 420 open

BO 305

Faltdürsystem

- raumsparend
- großzügiger Duscheinstieg
- Dichtungsverzicht bei überlappenden Glaselementen (40 mm)
- barrierefrei
- rahmengeführt

Folding door system

- Space saving
- Spacious shower entry
- Overlapping glass elements for seal-free design (40 mm)
- Barrier-free compatible
- Framedrive



1



2



3

1 Band Glas/Wand
Hinge glass/wall

2 Band Glas/Glas 180°
Hinge glass/glass 180°

3 Faltdürlaufwagen
Slide unit folding door

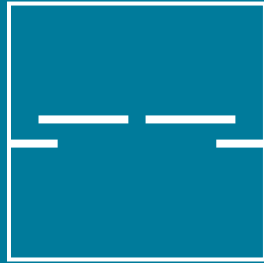

SCHIEBETÜRSYSTEME SLIDING DOOR SYSTEMS

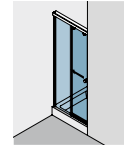

300(ü)

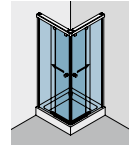

320(ü)

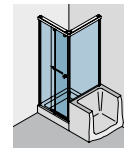

331(ü)

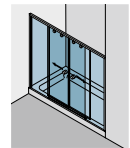

375(ü)

Hier sehen Sie nur eine kleine Auswahl möglicher Einbauvarianten. Alle mit dem System realisierbaren Anwendungstypen finden Sie ab Seite 36.

Here are a few installation examples. All realizable system application types see from page 36.

SO 720

Schiebetürsystem

- raumsparend
- raumhohe Nasszelle (Deckenmontage)
- Dichtungsverzicht bei überlappenden Glaselementen (77 mm)
- wandseitig ohne Profile

Sliding door system

- Space saving
- Room-height shower enclosure (ceiling fixing)
- Overlapping glass elements for seal-free design (77 mm)
- Sidewall without profiles

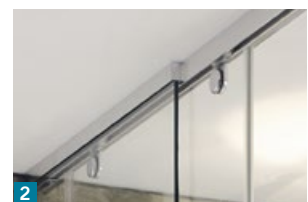

1 Schiebetürlaufwagen
Sliding door unit

2 Deckenmontage
Ceiling fixing

3 Griffmuschel
Pull grip

SO 730/3

Schiebetürsystem

- raumsparend
- 730 eckig/7303 rund
- Dichtungsverzicht bei überlappenden Glas-elementen (40 mm)
- wandseitig ohne Profile (auf Kundenwunsch)

Sliding door system

- Space saving
- 730 rectangular/7303 round
- Overlapping glass elements for seal-free design (40 mm)
- Sidewall without profiles (customizable)



1 SO 730 eckige Abdeckprofile
rectangular cover profiles

2 SO 7303 runde Abdeckprofile
round cover profiles

3 Schiebetürlaufwagen (innen)
Sliding door unit (inside)

SO 750

Schiebetürsystem

- raumsparend
- Edelstahl DIN 1.4404
- Dichtungsverzicht bei überlappenden Glas-elementen (70 mm)
- wandseitig ohne Profile

Sliding door system

- Space saving
- Stainless steel AISI 3162
- Overlapping glass elements for seal-free design (70 mm)
- Sidewall without profiles

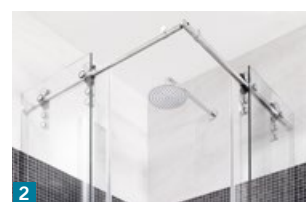

1 Typ(e) 320(ü) geschlossen
closed

2 Typ(e) 320(ü) geöffnet
open

3 Schiebetürlaufwagen
Sliding door unit

SF 740

11/12
2017

Schiebetürsystem

- raumsparend
- verdeckte Klemmlaufwagen (ohne Glasbearbeitung)
- vormontierte Funktionselemente
- beidseitiger Einzug inkl. beidseitiger Dämpfung
- stufenlos einstellbare Dämpfer
- einfache Montage (Einhängen des Türflügels)
- einfache Höhenverstellung
- einfache Reinigung
- Dichtungsverzicht bei überlappenden Glaselementen (40 mm)
- wandseitig ohne Profile (auf Kundenwunsch)

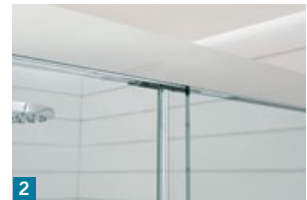

- 1 Eckverbindung
Corner connection
- 2 Laufrahmenprofil
Slide frame profile
- 3 ohne Wandanschlussprofil
Without sidewall profile

Sliding door system

- Space saving
- Concealed clamp-type carriers (no glass preparation)
- Pre-fitted functional elements
- Damping and self-closing on both door sides
- Infinitely variable damper position
- Easy installation (hang the door)
- Easy height adjustment
- Easy cleaning
- Overlapping glass elements for seal-free design (40 mm)
- Sidewall without profiles (customizable)



- 1 Schiebetür-Bodenführung
Sliding door-floor guide
- 2 teilbare Bodenführung
Separable floor guide
- 3 großzügiger Duscheinstieg
Spaciest shower entry



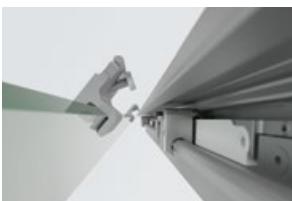

Einhängen des Türflügels
Hang the door



einstellbare Dämpfer
Variable damper position



Höhenverstellung
Height adjustment



Schiebetür Laufwagen (innen)
Sliding door unit (inside)

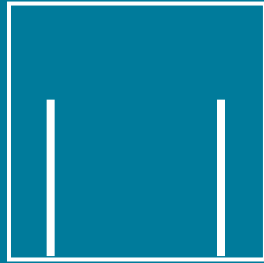

WALK-IN SYSTEME WALK-IN SYSTEMS

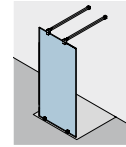

500

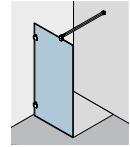

530W/P

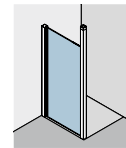

530

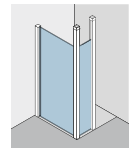

Erweiterung
Extension

Hier sehen Sie nur eine kleine Auswahl möglicher Einbauvarianten. Alle mit dem System realisierbaren Anwendungstypen finden Sie ab Seite 36.

Here are a few installation examples. All realizable system application types see from page 36.

Quadrat

Walk-In System

- frei begehbar, türenlos
- Stabilität durch Wandbefestigung
- großzügiger Duscheinstieg
- barrierefrei

Walk-in system

- Freely accessible, no doors
- Wall fixing for stability
- Barrier-free compatible
- Spacious shower entry

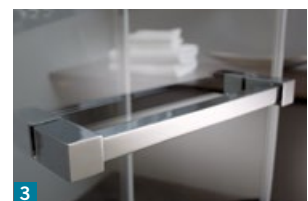

1 Haltestange Design Quadrat
Support bar Design Square

2 Bodenfixierung Design Quadrat
Floor fixing Design Square

3 Handtuchhalter Design Quadrat
Towel rail Design Square



PO 570

Walk-In System

- frei begehbar, türenlos
- Stabilität durch Wand-/ Deckenbefestigung
- großzügiger Duscheinstieg
- barrierefrei

Walk-in system

- Freely accessible, no doors
- Wall/ceiling fixing for stability
- Spacious shower entry
- Barrier-free compatible



1 Deckenbefestigung
Ceiling fixing

2 Bodenanschluss
Ground connection

3 Wandprofil
Wall profile

Typ(e) 530

Walk-In Lösung – Beschlagserie nach Wahl

- frei begehbar, türenlos
- Stabilität durch Wandbefestigung
- großzügiger Duscheinstieg
- barrierefrei
- Winkel (W) oder Profile (P)

Walk-in solution shower hinge series

- Freely accessible, no doors
- Wall fixing for stability
- Barrier-free compatible
- Spacious shower entry
- Bracket (W) or profile (P)



1 Winkel Glas/Wand 90°
Bracket glass/wall 90°

2 Haltestange (eckig/rund)
Support bar (square/round)

3 Wandprofil
Wall profile

DUSCHSYSTEME/ -BESCHLÄGE FÜR SONDERLÖSUNGEN SHOWER SYSTEMS AND FITTINGS FOR SPECIAL SOLUTIONS

Besondere Raumsituatio-
nen benötigen besondere
Duschbeschläge. Ob im
öffentlichen oder privaten
Einsatzbereich, gral Dusch-
beschläge überzeugen auch
hier mit einer großen
Variantenvielfalt. Für jede
Sondersituation gibt es eine
Lösung – sprechen Sie uns
an.

Extraordinary room situations
require specialized shower
solutions. Regardless if in
a private or public solution,
gral showers systems pro-
vide a convincing variation to
suite all needs. For all
special situations we have
a solution. Feel free to con-
tact us.

BF 134

Pendeltürsystem T-Beschläge für Duschtüren

- T-Band Glas/Glas 90°/180°
- Beschläge für Türflügel
und Trennwände
- nach innen/außen öffnend
- selbstschließend ab 20°

Double-action door system T-Fittings for shower doors

- T-Hinge glass/glass
90°/180°
- Fittings for door panels
and partition walls
- Inward/outward opening
- Self-closing from 20°



1 T-Band Glas/Glas 90°/180°
T-Hinge glass/glass 90°/180°

2 Winkel Glas/Wand 90°
Bracket glass/wall 90°

3 Sonderlösung geöffnet
Special solution, opened

BF 134

Pendeltürsystem T-Winkel für DusCHFestteile

- T-Winkel Glas/Glas 90°/180°
- Beschläge für Festteile und Trennwände

Double-action door system T-Fittings for fixed panels

- T-Bracket glass/glass 90°/180°
- Fittings for fixed panels and partition walls



1



2

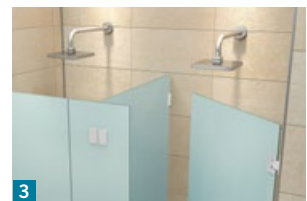

3

1 T-Winkel Glas/Glas 90°/180°
T-bracket glass/glass 90°/180°

2 Band Glas/Wand 90°
Hinge glass/wall 90°

3 Sonderlösung geöffnet
Special solution, opened

BO 410/415

Laschen-/Winkel-Verbindungen für DusCHFestteile

- für 135°/180° Anwendungen
- Glas/Wand-Beschläge (für Festteile an Mauervorsprung)
- Glas/Glas-Beschläge (für Verbindung von Festteilen)

Connector-/Bracket Connections for shower fixed panels

- For 135°/180° applications
- Glass/wall fittings (for fixed panels on wall)
- Glass/glass fittings (for connection of fixed panels)

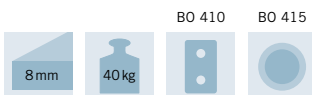

1



2



3

1 Lasche Glas/Wand 180° (BO 410)
Connector glass/wall 180°

2 Lasche Glas/Wand 180° (BO 415)
Connector glass/wall 180°

3 Lasche Glas/Glas 180° (BO 415)
Connector glass/glass 180°

BO 410/415

Anschlagtürsystem Ecklösung auf Mauerwerk

- nach außen öffnend
- für 135° Anwendungen
- Band Glas/Wand mit Anschraubflasche außen (Sonderl. siehe 2)

Single-action door system corner solution on wall

- Outward opening
- For 135° applications
- Hinge glass/wall with reversible external fixing plate (special see 2)

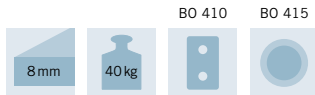

1



2



3

1 Band Glas/Glas 135°
Hinge glass/glass 135°

2 Sonderl. Band Glas/Wand 135°
Special hinge glass/wall 135°

3 Vierkantprofil + Magnetdichtung
Square profile + magnetic seal

BO 415

Anschlagtürsystem Ecklösung an Mauervorsprung

- nach außen öffnend
- Band Glas/Wand mit Anschraubflasche außen (s. 1)
- Winkel Glas/Wand mit Anschraubflasche außen (s. 2)

Single-action door system corner solution on wall

- Outward opening
- Hinge glass/wall with reversible external fixing plate (special see 1)
- Bracket glass/wall with reversible external fixing plate (special see 2)



1



2



3

1 Sonderlösung Band Glas/Wand
Special Hinge glass/wall

2 Sonderl. Winkel Glas/Wand 90°
Special Brackets glass/wall 90°

3 Haltestange Glas/Wand
Support bar glass/wall

SO 730

Schiebetürsystem Dusch-/WC-Lösung

- raumsparend
- T-Sonderlösung
- einflügelige Schiebetür
- wahlweise Dusch- oder WC-Bereich geschlossen

Sliding door system Shower-/WC-Solution

- Space saving
- T-special solution
- Single sliding door
- Shower or WC area optionally closed



1

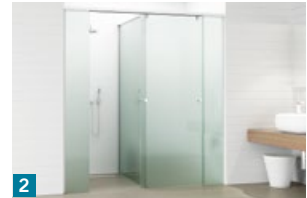

2



3

- 1 WC-Bereich offen
WC area open
- 2 Dusch-Bereich offen
Shower area open
- 3 Schiebetürlaufwagen (außen)
Sliding door unit (outside)

SO 730

Schiebetürsystem Ecklösung am Mauervorsprung

- raumsparend
- optimierter Duscheinstieg, Schiebetür läuft hinter die Wand
- Sonderbearbeitung des Laufrahmenprofils (siehe 2)

Sliding door system Corner Solution on wall

- Space saving
- Optimized shower entry, sliding door behind the wall
- Slide frame profile with special preparation (see 2)



1



2



3

- 1 optimierter Duscheinstieg
Optimised shower entry
- 2 Laufrahmenprofil (innen)
Slide frame profile (inside)
- 3 Schiebetürlaufwagen (außen)
Sliding door unit (outside)

PROFILE & ZUBEHÖR PROFILES & ACCESSORIES

- Aluminiumprofile
- Kunststoffprofile
- Türgriffe
- Haltestangen
- Handtuchstangen
- Glasablage
- Aluminium profiles
- Plastic profiles
- Door handles
- Support bars
- Towel rails
- Glass shelf

Für nahezu jede Duschsituation die richtigen Dicht-/Schwallschutzprofile, Magnetdichtungen und Wasserabweiser, sowie das umfangreiche Aluminiumprofilprogramm. Dazu passendes Zubehör wie Griffe, Handtuchhalter, Haltestangen, Glasablagerungen im runden oder quadratischen Design.

The range that offers the right sealing/anti-flooding profiles, magnetic gaskets and water deflectors together with a comprehensive range of aluminum extrusions. A comprehensive range of accessories like handles, towel holders, support bars, glass shelf in rectangular or square design.

Aluminium- und Kunststoffprofile | Aluminium profiles and Plastic profiles

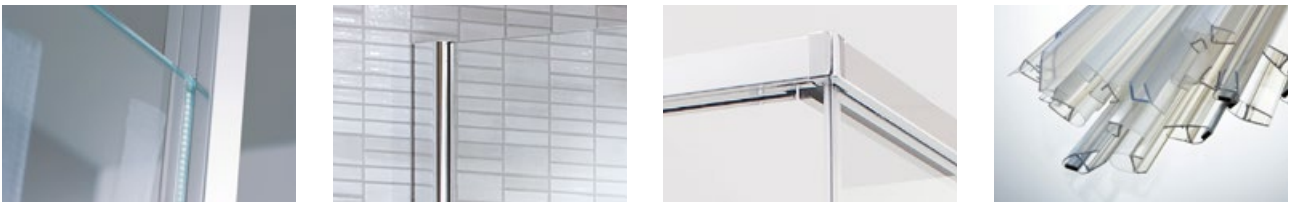

Haltestangen | Support bars

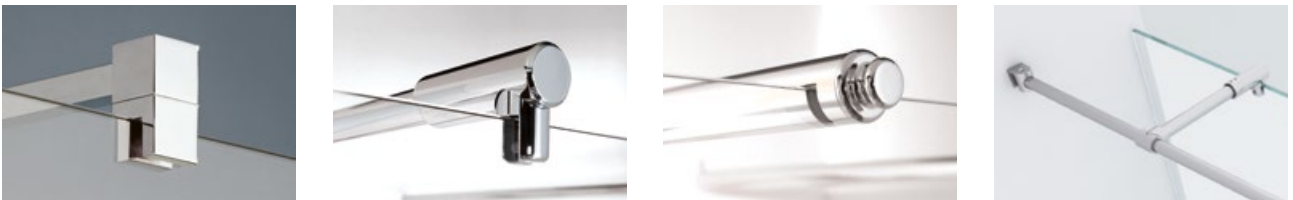

Handtuchstangen · Türgriffe · Glasablage | Towel rails · Door handles · Glass shelf

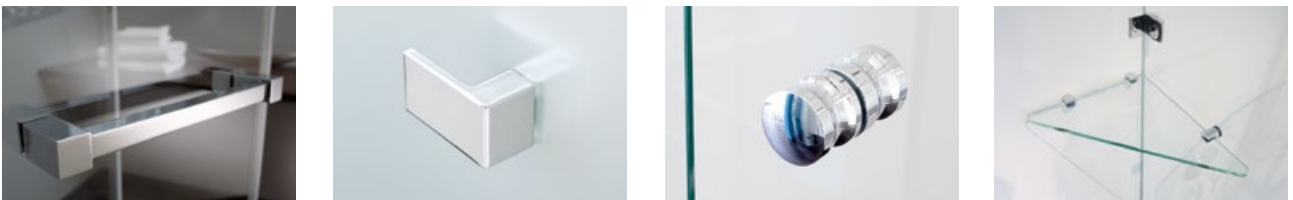

Alle gral Duschbeschlagserien (Basismaterial Messing) sind Qualitätsprodukte. Produktzertifizierungen und unterschiedliche Ausstellungsmodulare unterstützen Sie bestens bei der Bewerbung und Planung bis zur finalen Objektrealisation.

gral shower hinge series (basic material brass) are all of high quality. Product certifications and different demonstration modules will help you beginning of promotion and planning till to final object realisation.

PRODUKTZERTIFIZIERUNG & AUSSTELLUNGSMODULE

PRODUCT CERTIFICATION & DEMONSTRATION MODULES

- Produktzertifizierung
- Musterkoffer
- Tischfunktionsmuster
- Mobiler Präsentier I
- Mobiler Präsentier II
- Product certification
- Sample case
- Desktop Demo Units
- Mobile Presentation Unit I
- Mobile Presentation Unit II

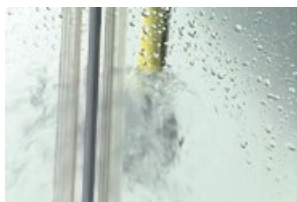

Produktzertifizierung

Product certification

gral Duschesysteme und Beschlagserien sind gemäß der europäischen DIN EN 14428 (CE-Kennzeichnung) auf Stabilität, Dauerhaftigkeit und Dichtigkeit erfolgreich getestet.

gral shower systems and hinge series are tested according to the European EN 14428 (CE marking) of Stability, durability and water-tightness.



Musterkoffer | Sample case

Hochwertiger Musterkoffer aus Aluminium zur Präsentation einzelner Duschbeschlagskomponenten.







High-quality sample case of aluminium for presentation of single shower hinge components.



Art.-Nr. | Art. No. 877.995.99999
Preis netto | Price net 500,00 €



Inhalt | Content

- BO 410 
- BF 112 
- BO 381 
- BF 134  
- BH 2401  

Genauere Beschlagsauswahl siehe gral Preisliste oder separates Informationsblatt.

Detailed fittings range see gral price list or separate information sheet.

Tischfunktionsmuster | Desktop Demo Units

Ideal für Produktpräsentationen, technische Schulungen, wo die Funktionen der Duschbeschläge im eingebauten Zustand dargestellt werden. Komplett montiert, einfaches Handling. Perfekt als zusätzliches Ausstellungsmodul im Showroom.

For product presentations and technical training courses where the functions of the shower fittings need to be demonstrated in their installed condition. Completely assembled, easy to use. Ideal as an additional exhibition module in the showroom.



Art.-Nr. und Serien siehe gral Preisliste | Art. No., and Series see gral price list – Preis netto | Price net 170,00 €

Mobiler Präsenter I | Mobile Presentation Unit I

Das bewegliche Ausstellungsmodul zur Präsentation individueller Ganzglasduschen. Verfügbar in Basisfarbe Schwarz/Weiß. Maximale Darstellung von vier verschiedenen Band-System-/Serien. Bestückung nach Wunsch. Wir beraten Sie gerne bei der Produkt-Zusammenstellung.

The wheeled demonstration module for presentation of individual glass shower systems. Available in basic colour black/white. Maximum representation of four different hinge-system-/series. Assembly on request. We will be glad to assist you in your product compilation.



Geeignet für jede gral Duschbeschlagserie
Suitable for all gral shower fitting series

Abmessung (B×T×H)
Dimension (W×D×H)
1 250 × 1 250 × 2 252 mm

Preis netto | Price net
inkl. Glas | incl glass 1 950,00 €
optional ohne Glas |
optionally without glass 1 780,00 €

Mobiler Präsenter II | Mobile Presentation Unit II

Das bewegliche Ausstellungsmodul mit vordefinierter Bestückung. Ausgearbeitet und ideal für kleine Ausstellungsräume, Haus- und Fachmessen. Verfügbar in Basisfarbe Weiß, komplett vormontiert, mit seitlichen Prospekthaltern.

The wheeled demonstration module with predefined exhibit locations. Ideal for small exhibition areas and in-house and trade fairs. Available in the basic colour white, completely pre-assembled, with brochure holders on the sides.



Ausstattung | Configuration



BH 2401



BF 112

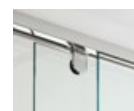

SO 720



BH 415















BO 460



BO 410

Abmessung (B×T×H)
Dimension (W×D×H)
2 000 × 600 × 1 950 mm

Art.-Nr. | Art. No. 890 004 00099
Preis netto | Price net 1 800,00 €

										
										
Duschsystem Shower system	BO 410	BO 415	BO 460	BH 200	BH 205	BH 210	BH 2401	BH 410	BH 415	BF 111
Basismaterial Basic material	Messing Brass	Messing Brass	Messing Brass	Messing Brass	Messing Brass	Messing Brass	Messing Brass	Messing Brass	Messing Brass	Messing Brass
DIN EN 14428 DIN EN 14428	■	■	■	■	■	■	■	■	■	
Anschlagtürbeschläge Single-action door fittings	■	■	■	■	■	■		■	■	
Pendeltürbeschläge Double-action door fittings							■			■
Schiebetürbeschläge Sliding door fittings										
Faltdürbeschläge Folding door fittings										
frei begehbar, türenlos Freely accessible, no doors										
fluchtende + überlappende Bänder Inline + overlapping hinges	■	■								
durchg. Dichtung im Bandbereich Continuous seal in hinge area	■	■	■	■	■	■		■	■	
einstellbare Nullstellung Adjustable zero position										■
selbstschließend Self-closing				■	■	■	■	■	■	■
Soft-closing Soft-closing										
verdeckte Wandbefestigung Concealed wall fixing	■	■	■	■	■	■	■	■	■	
flächenbündige Glasbefestigung Countersunk glass fixing		■	■		■	■	■		■	
Türbänder mit Langlöchern Door hinges with oblong holes	■	■		■		■		■	■	
mit gebogenen Türflügeln With curved door panels	■	■		■	■	■		■	■	
max. Tragfähigkeit (2 Beschläge) Max. loading capacity (2 fittings)	40 kg	40 kg	30 kg	40 kg	30 kg	40 kg	40 kg	40 kg	40 kg	40 kg

 **BO 410**

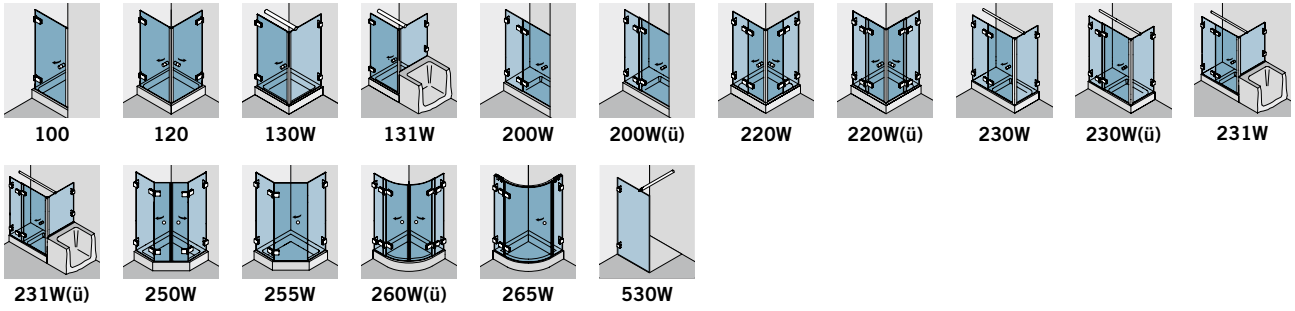

 **BO 415**

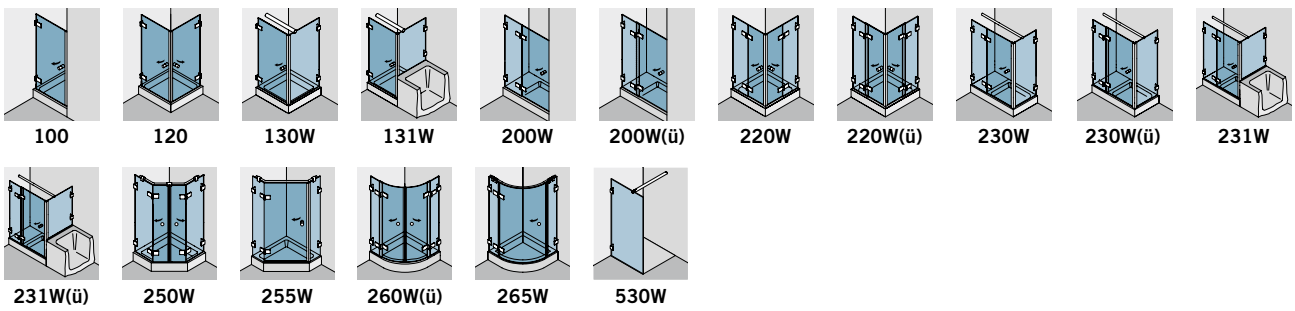

 **BO 460**



 **BH 200**

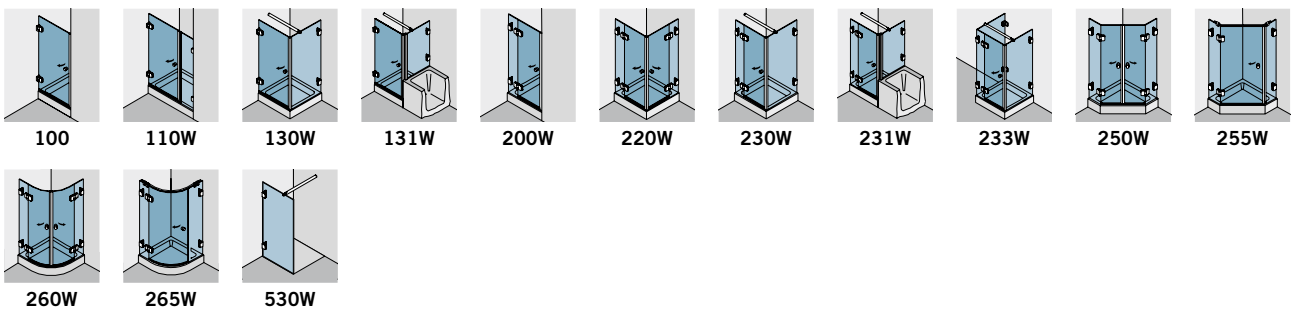

↑↓ **BH 205**

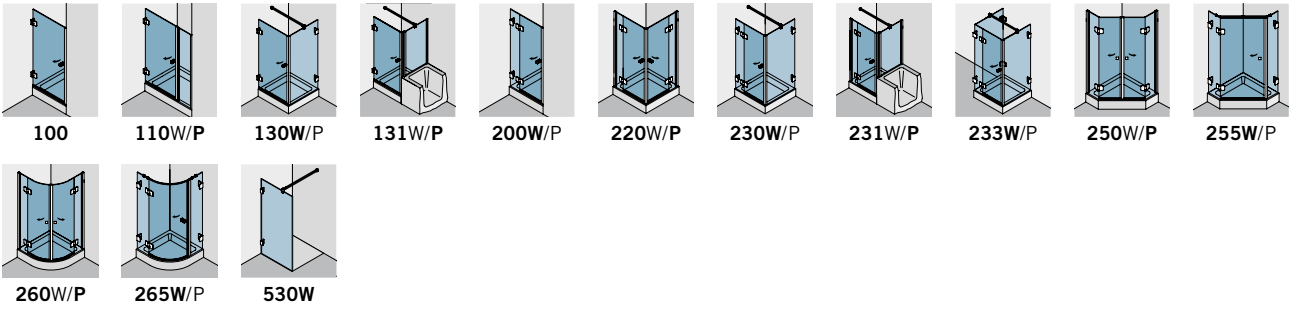

↑↓ **BH 210**

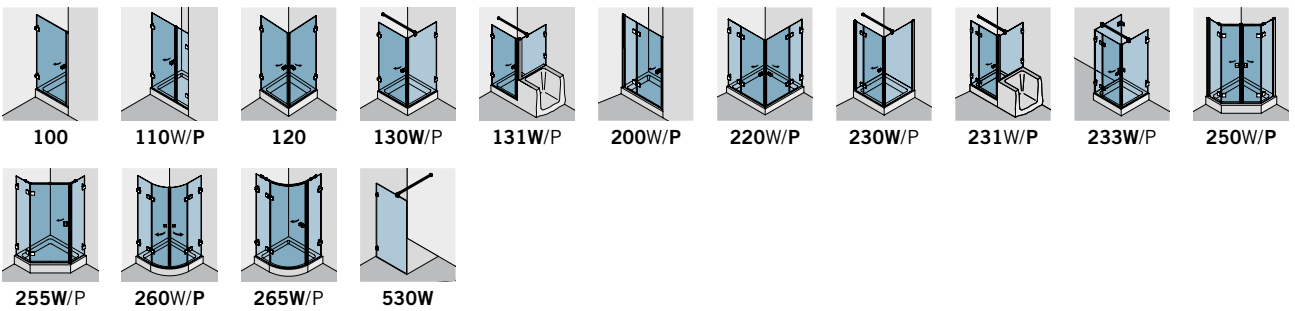

↑↓ **BH 2401**

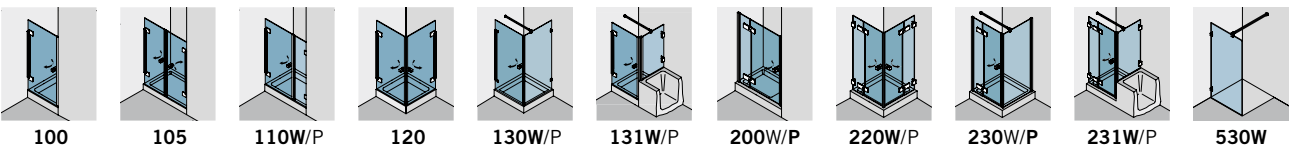

↑↓ **BH 410**

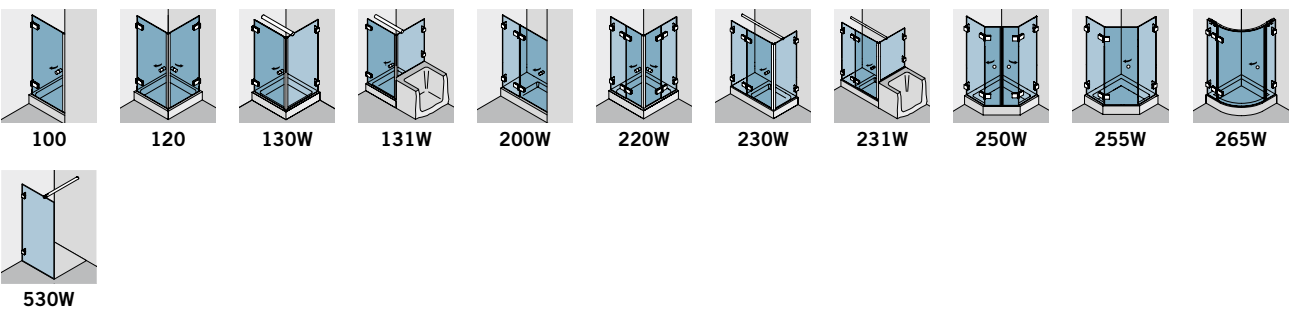

↑↓ **BH 415**

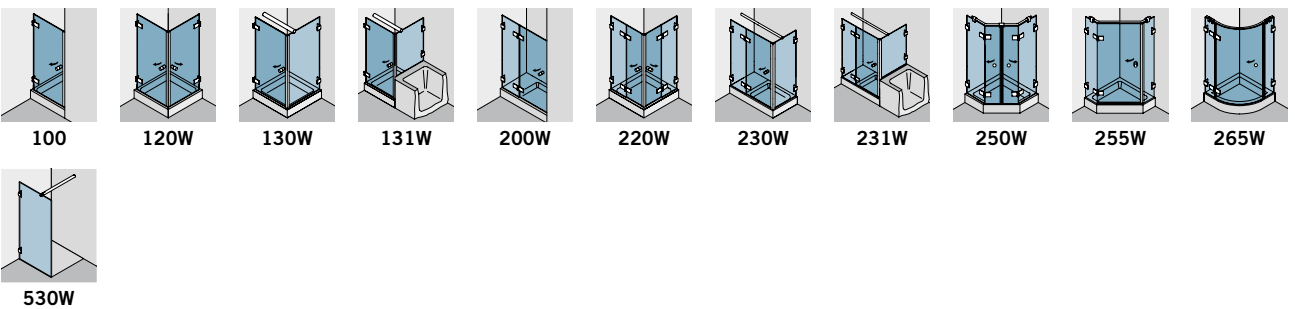

 **BF 112/BF 112 XL**

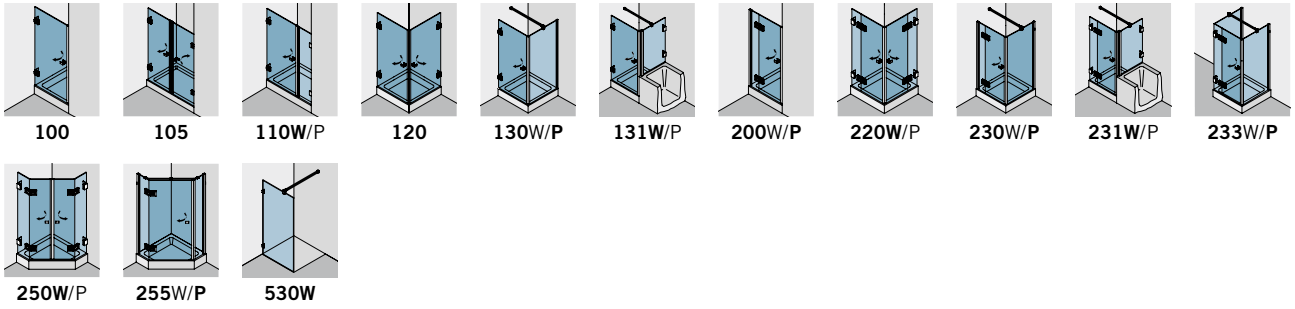

 **BF 134**

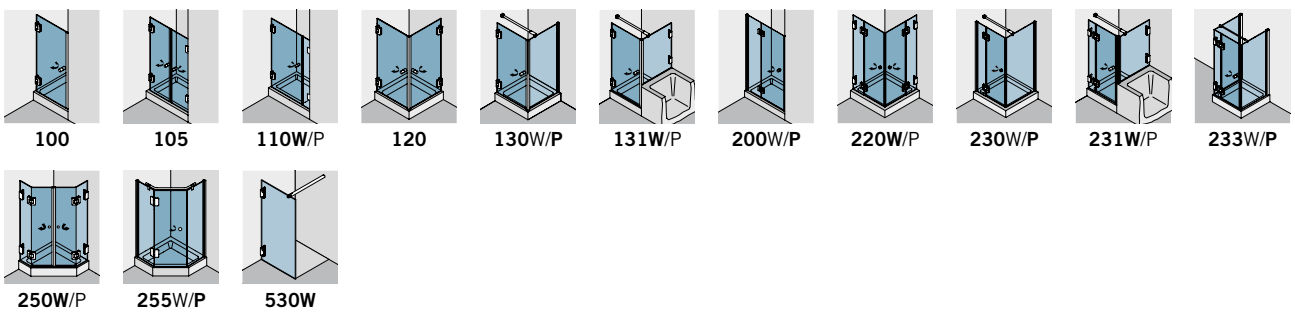

 **BO 381**

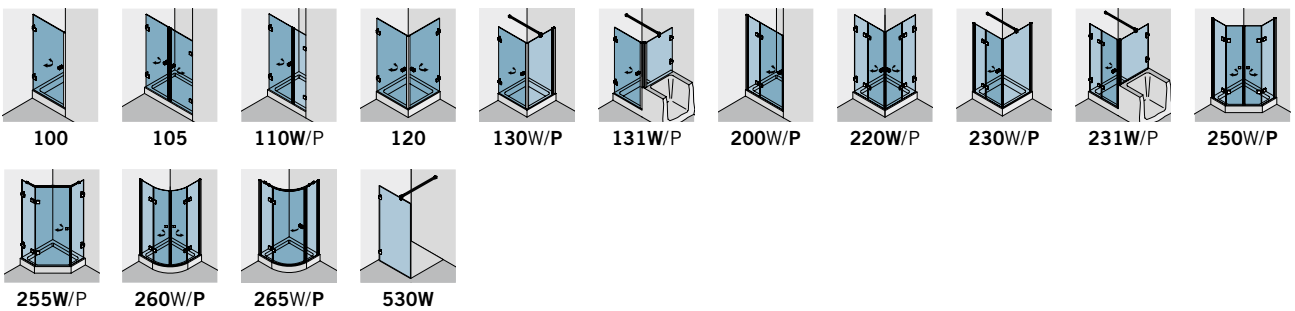

 **BH 2401**

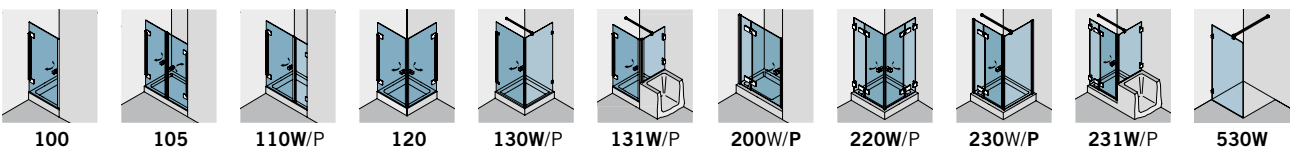

 **BF 134**

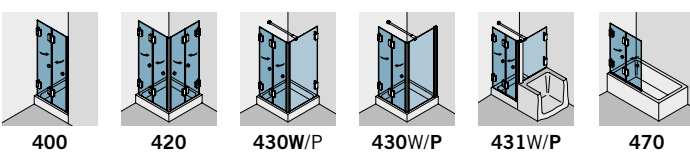

BO 305

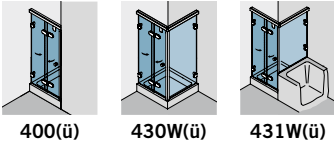

400(ü)

430W(ü)

431W(ü)

SO 720

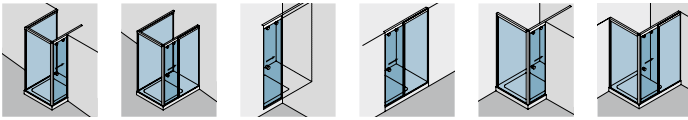

390(ü)

391(ü)

392(ü)

393(ü)

394(ü)

395(ü)

SO 730/3

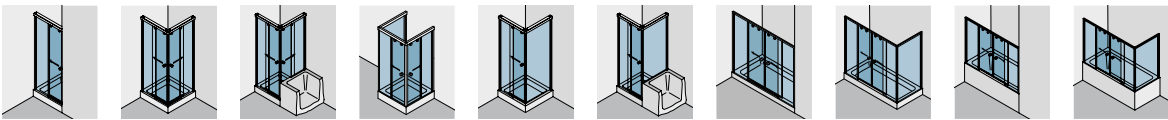

300(ü)

320(ü)

321(ü)

323(ü)

330(ü)

331(ü)

375(ü)DT

380(ü)DT

375(ü)BW

380(ü)BW

SO 750

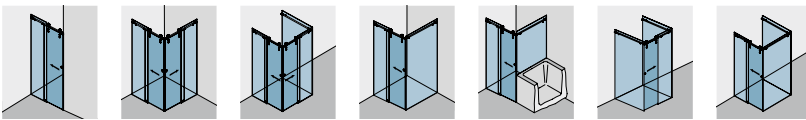

300(ü)

320(ü)

323(ü)

330(ü)

331(ü)

333(ü)

334(ü)

SF 740

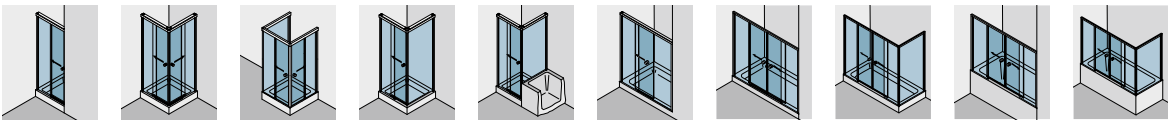

300(ü)

320(ü)

323(ü)

330(ü)

331(ü)

370(ü)

375(ü)DT

380(ü)DT

375(ü)BW

380(ü)BW

QUADRAT

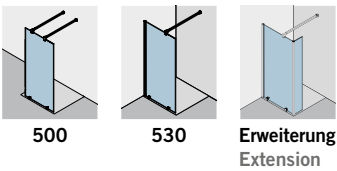

500

530

Erweiterung

Extension

PO 570

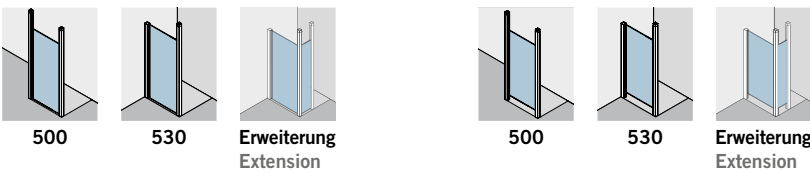

500

530

Erweiterung

Extension

500

530

Erweiterung

Extension



**Gral Systeme GmbH
Niederlassung Rietberg**

Ludwig-Erhard-Straße 7
33397 Rietberg
GERMANY

Phone +49 (0) 5244 9076-0
Fax +49 (0) 5244 9076-219

www.gral-systeme.de